

Instruction

Changing pistons APP 21-43



Instruction **Changing pistons APP 21-43**

Contents

1.	Disassembling	3
2.	Assembling	6
3.	When should the pistons be replaced.....	8
4.	Parts list for APP 21-38.....	9
5.	Exploded view 21-26	10
6.	Exploded view 30-43.....	11

This document covers the instructions for changing the pistons on the axial piston pumps APP 21-43.

Note : It is essential that the pump is serviced in conditions of absolute cleanliness.

- Tools needed are:
- 13 mm combination wrench
 - 6 mm allen key

Service Kit - see parts list 521B0941.



1. Disassembling

To understand the pump design better, please see cross section diagram on last page.

1. Disconnect the pump from the rest of the system.

2. Loosen all screws on the pump except the three screws as shown in the picture below.

WARNING:
Never unscrew the 4 screws marked with coloured sealer.

Note: There is still water inside the pump.

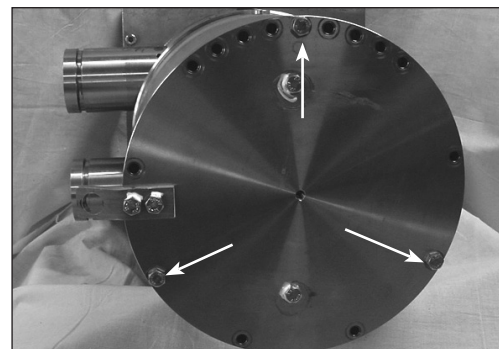
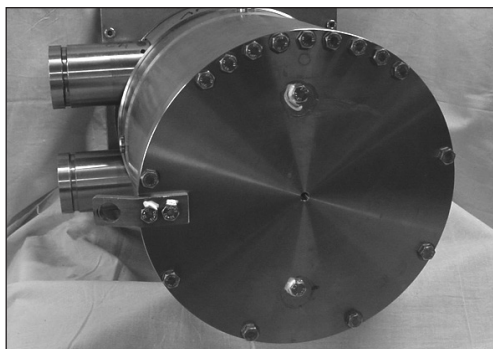

3. Mount the guide bolt in the top hole.

4. Unscrew the remaining three screws by using the combination wrench to turn each screw a couple of rounds at a time so the flange is removed as straight forward as possible.

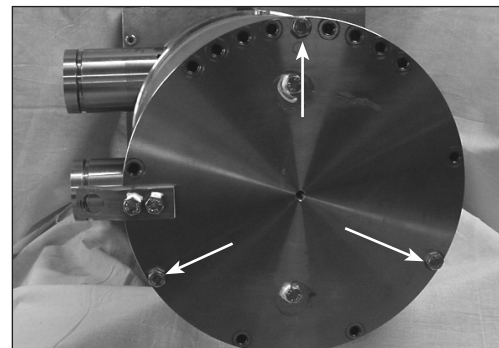
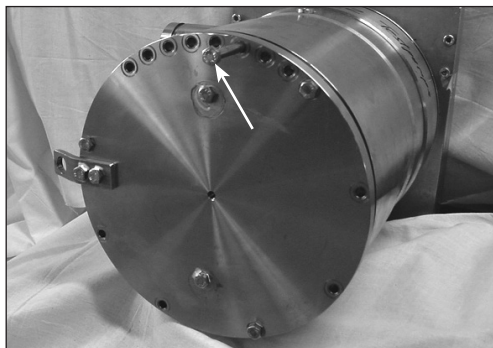

5. If the flange does not move forward - loosen the drain plug to empty the pump from water by releasing vacuum.

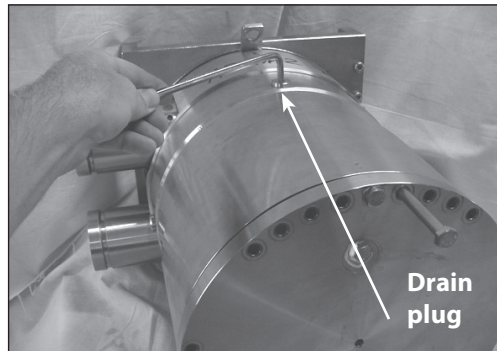

6. Remove the flange when the remaining three screws have been loosened. The guide bolt must remain mounted.

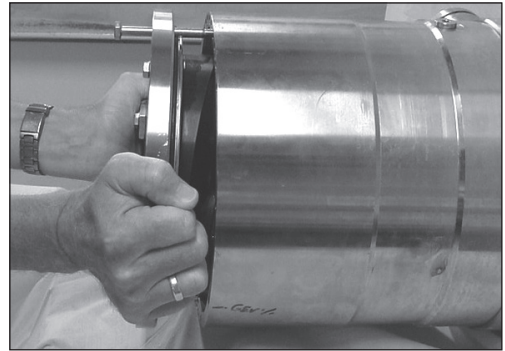

7. Carefully turn the flange and push it backwards to make it rest on the housing surface. Ensure not to scratch the swash plate surface.

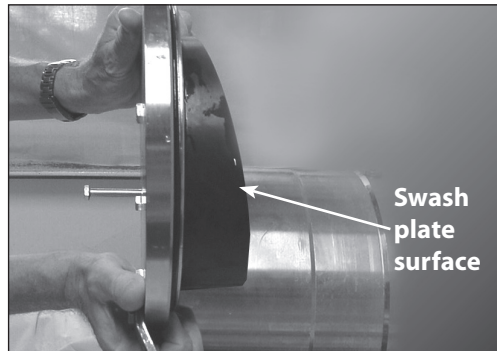

8. Adjust the retainer plate to be parallel to the end flange.

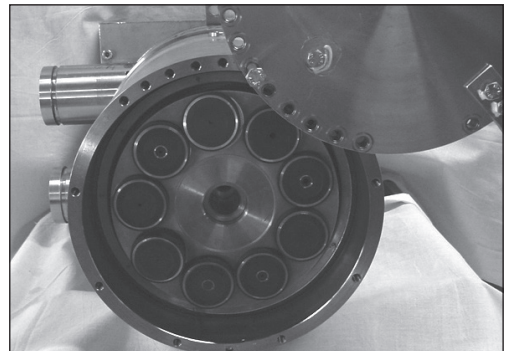

9. Screw the stop for the retainer ring into the centre to keep the retainer ball in place.

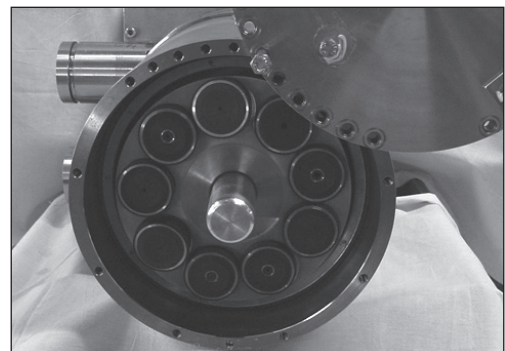
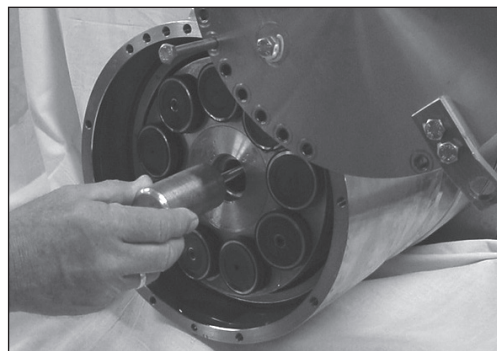

10. Carefully remove the pistons one by one.

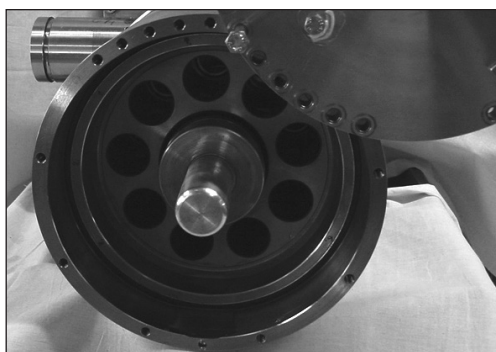
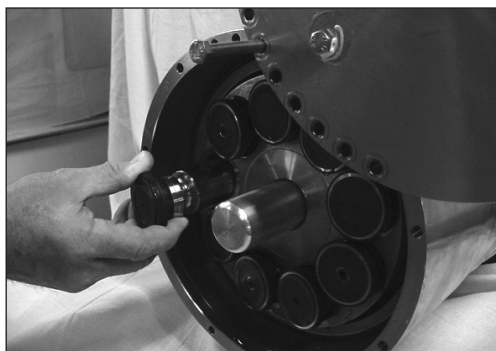

11. **Warning:**
Ensure that the piston shoes and the piston surfaces are not damaged during removal. It is recommended to place the pistons upside down on an even and clean base/surface.



12. Remove the retainer ring by sliding it across the stop for the retainer ball. If necessary, tilt the flange.

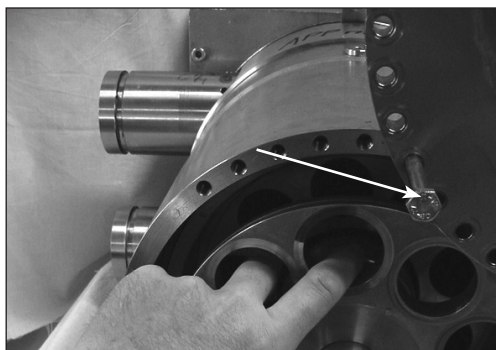

13. Inspect the piston liners.

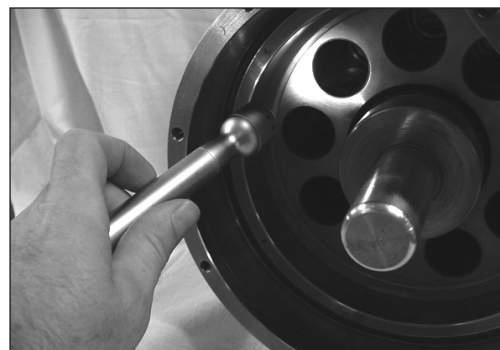

14. Replace any worn parts.

2. **Assembling**

1. Carefully push the retainer ring in place.

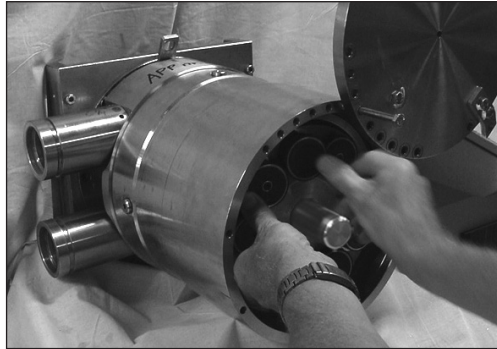

2. Lubricate pistons with clean filtered water. Insert the pistons arbitrarily.

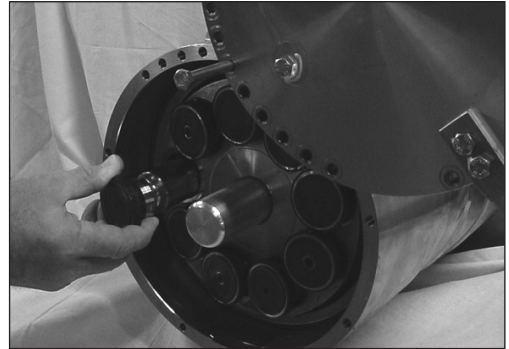

3. Remove the stop for retainer ball.

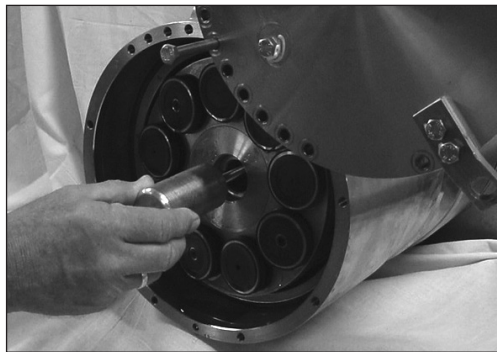

4. Place the retainer ring in an odd angle corresponding to the orientation of the swash plate.

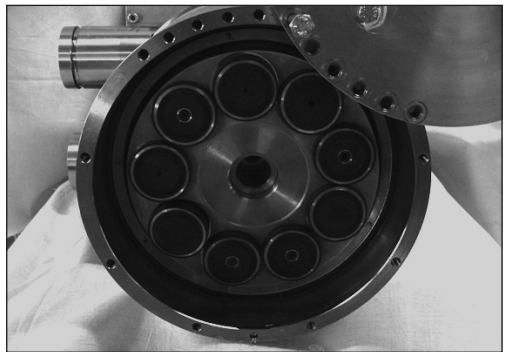

5. Tilt the flange and replace the flange O-ring.

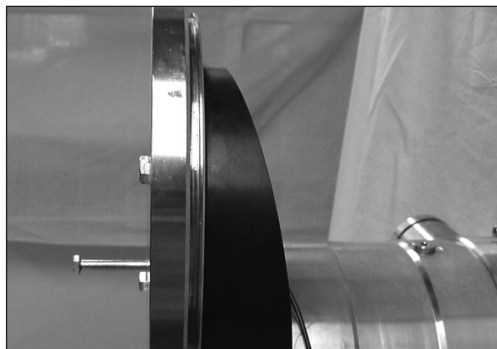

6. Turn the flange and gently push it into the housing.

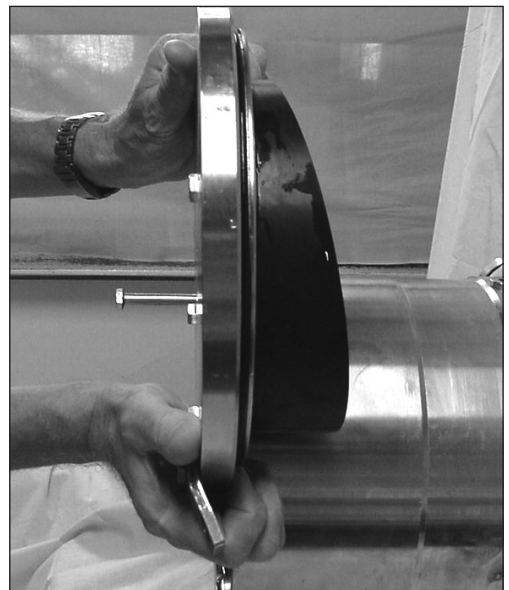

7. Mount the three screws as shown below. Tighten them to a torque of $30 \text{ Nm} \pm 3 \text{ Nm}$.

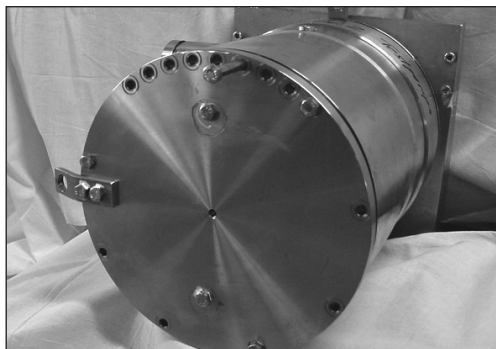

8. Remove the guide bolt.

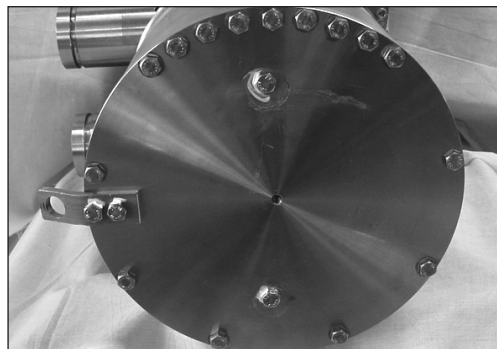

9. Mount the remaining screws and cross tighten them to a torque of $30 \text{ Nm} \pm 3 \text{ Nm}$.

10. Connect the pump to the rest of the system.

11. Bleed the pump.

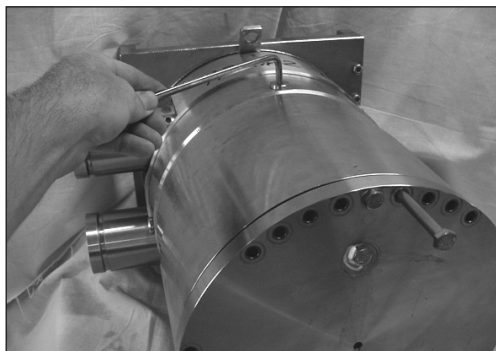

Instruction**Changing pistons APP 21-43**

3. When should the pistons be replaced

This section provides guidance on, how to determine whether the parts of the APP 21-43 are worn and should be replaced. In case of doubt - the pistons must be replaced. The pictures below are ment as a guideline for evaluating the wear of the sliding surface.

Note: If the pistons break down, the pump will suffer a disastrous breakdown.

Picture 1:

No wear or cavitation of the piston shoe.
New inspection is required in 4,000 hours.

Picture 2:

Cavitation of the piston shoes.
New inspection is required in 2,000 hours.

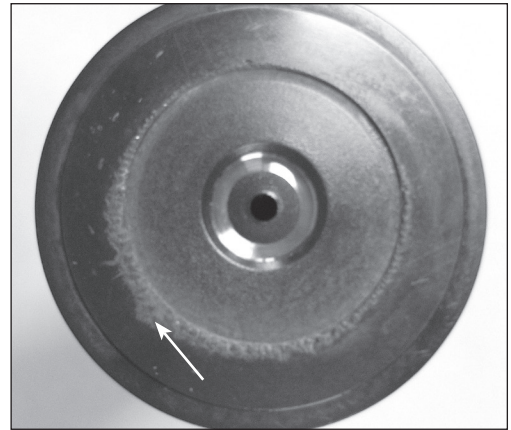
**Picture 3:**

Cavitation of the piston shoes.
All pistons must be replaced within the next 1,000 hours.



4. Parts list for APP 30 - 43

Pos.	Qty.	Unit	Designation	Material
1	1	Pc.	Housing	Duplex / PEEK
2	2	Pcs.	Pin (Ø6x10)	AISI 316
3	2	Pcs.	Bleeding plug	Super Duplex
4	4	Pcs.	O-ring (Ø11.0x2.0)	NBR
5	17	Pcs.	Screw M8x30	AISI 316
9	1	Pc.	O-ring (Ø228x4)	NBR
10	2	Pcs.	O-ring (Ø9.19x2.62)	NBR
11	1	Pc.	End flange	Duplex
12	1	Pc.	Lifting eye	AISI 3169
13	1	Pc.	Screw M8x16	AISI 316
31	1	Pc.	Swash plate	Super Duplex
34	2	Pcs.	Pin (Ø10.5x20)	Duplex
61	1	Pc.	Cylinder barrel	Super Duplex / PEEK
62	4	Pcs.	Spring	Duplex
63	1	Pc.	Spring guide	PP
64	1	Pc.	Retainer ball	Super Duplex/DLC
65	1	Pc.	Retainer plate	Super Duplex
66	9	Pcs.	Piston	Super Duplex / PEEK
67	1	Pc.	Key 12x8x70	AISI 316
71	1	Pc.	Retainer guide	Super Duplex / PEEK
80	4	Pcs.	Spacer	Super Duplex
91	1	Pc.	Port plate	Super Duplex / PEEK
92	1	Pc.	Valve plate	Super Duplex
93	9	Pcs.	Back-up ring	PTFE
94	9	Pcs.	O-ring (Ø30.2x3)	NBR
121	1	Pc.	Port flange	Duplex / PEEK
122	1	Pc.	O-ring (Ø68x2)	NBR
123	1	Pc.	O-ring (Ø228x4)	NBR
124	1	Pc.	Shaft seal	Hastelloy/NBR
125	1	Pc.	Cover for shaft seal	Super Duplex
126	2	Pcs.	Pin (Ø10.5x20)	Duplex
127	4	Pcs.	Screw	AISI 316
128	15	Pcs.	Screw M8x90	AISI 316
142	1	Pc.	Stop for shaft seal	PP
144	4	Pcs.	Tailstock screw M12x60	AISI 316
145	4	Pcs.	Check nut M12	AISI 316
146	1	Pc.	Lifting eye	AISI 316
147	1	Pc.	Screw M8x16	AISI 316
151	1	Pc.	O-ring (Ø35x3)	FPM 75
152	1	Pc.	Valve cone	Super Duplex
153	1	Pc.	Spring (Ø1.9xØ25.0x33.7)	Duplex
154	1	Pc.	Plug/guide	Super Duplex
155	1	Pc.	O-ring (Ø47.22x3.53)	NBR
			Instruction	

5. Exploded view
APP 21-26

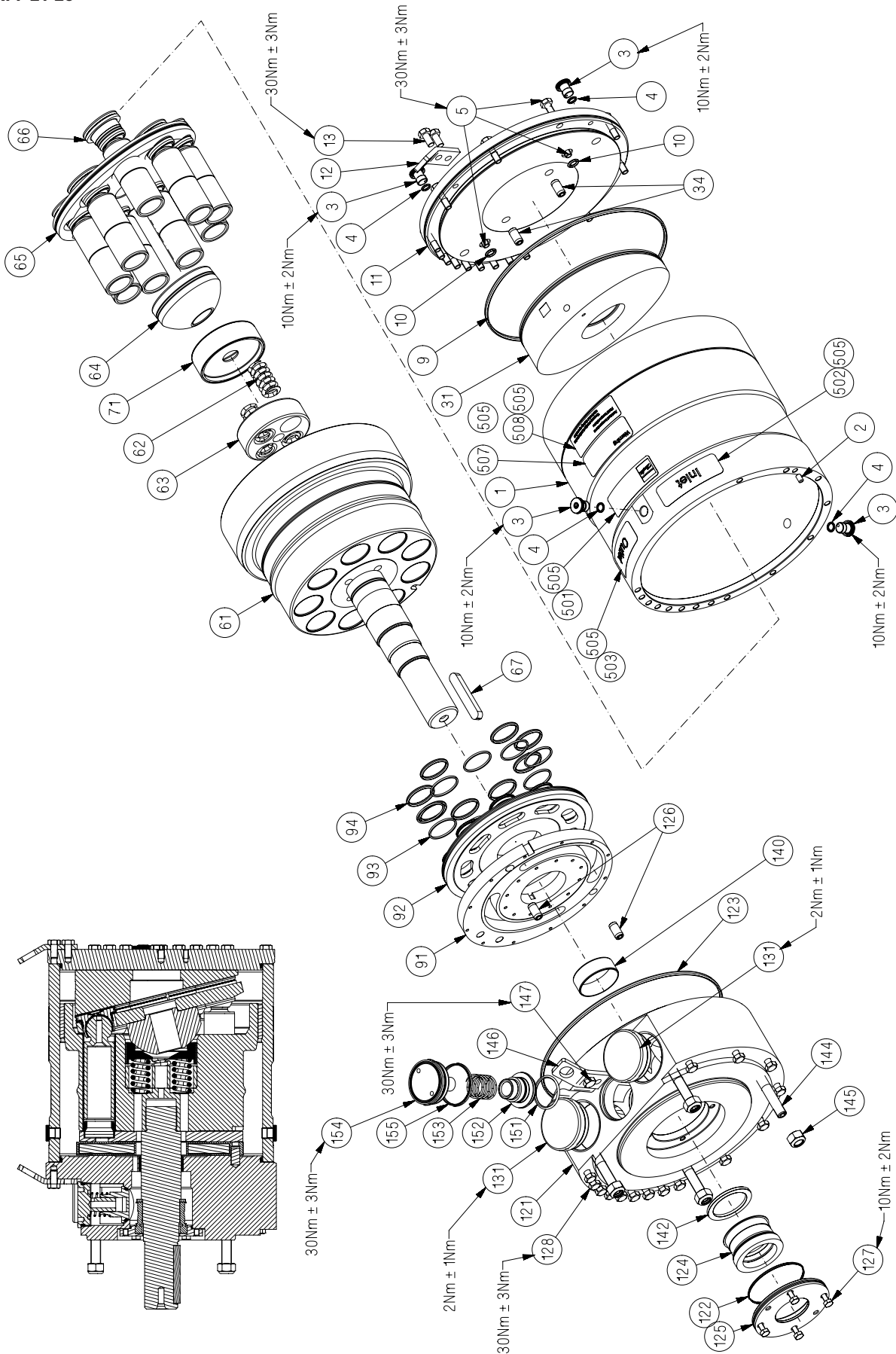

6. Exploded view
APP 30-43

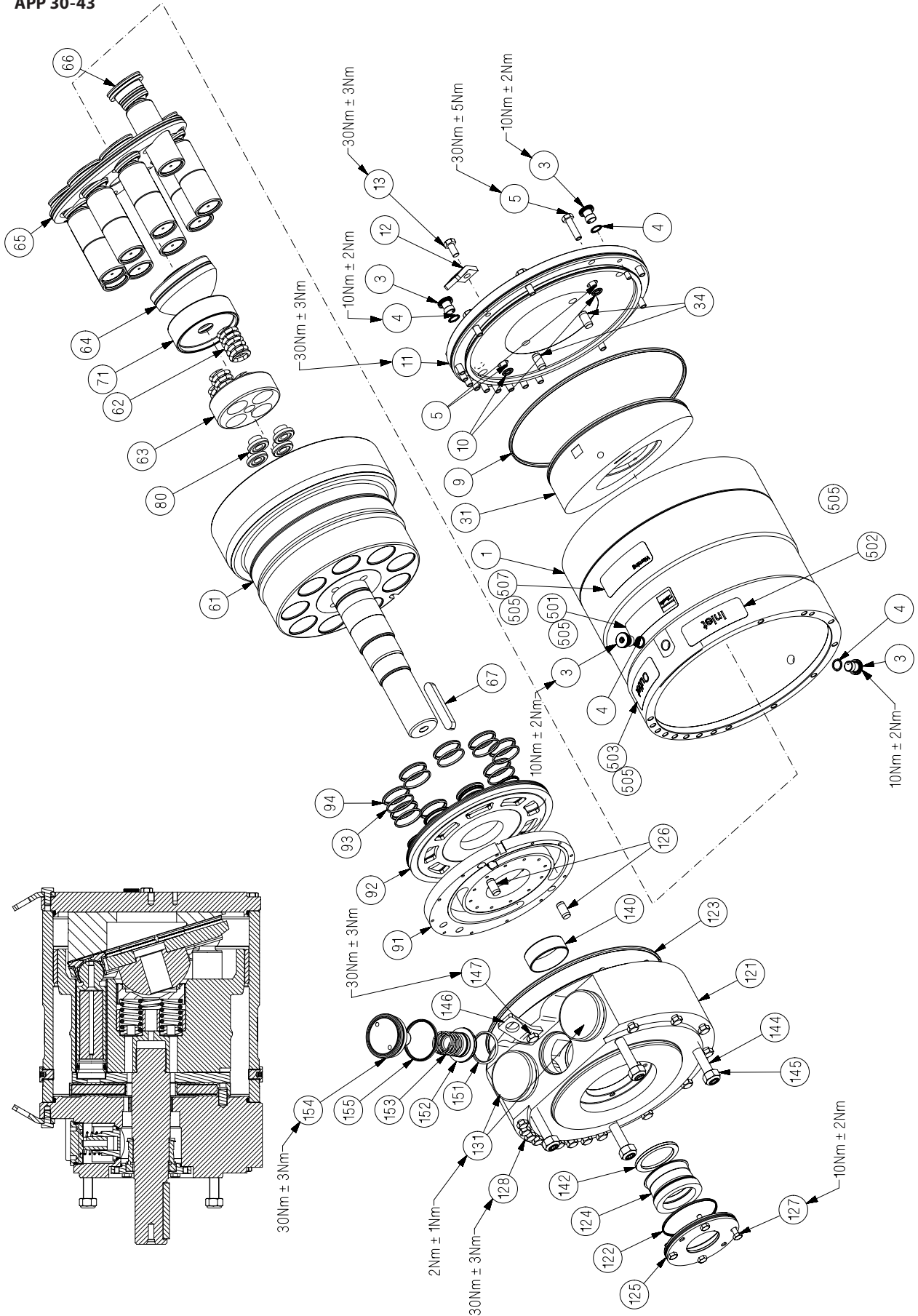

Danfoss A/S
High Pressure Pumps
DK-6430 Nordborg
Denmark

Danfoss can accept no responsibility for possible errors in catalogues, brochures and other printed material. Danfoss reserves the right to alter its products without notice. This also applies to products already on order provided that such alterations can be made without subsequential changes being necessary in specifications already agreed. All trademarks in this material are property of the respective companies. Danfoss and the Danfoss logotype are trademarks of Danfoss A/S. All rights reserved.
